

The following features are available in this PDF document.



Quick Keyword Search

Enter the keyword in the search box and hit the search button



Quick Jump between Chapters

Click the title of a specific chapter on the Contents to jump to it

*Reading software such as Adobe Reader is needed to support the functions above.



CRANE 3 LAB

User Guide

Contents

■ Packing List	
■ Get to Know CRANE 3 LAB	
Get to Know CRANE 3 LAB	2
■ Interfaces Instruction	
Camera Image Transmission and Control Module	3
■ Charging Procedure	
Charger and Battery Description	4
Charging Procedure	5
■ Installation	
Tripod Installation	6
Battery Installation	6
Camera Installation	7
Data Cable Connection	8
Balance Adjustment	10
■ How to Use	
Buttons Description	12
OLED Display Description	14
Menu Option Description	15
Motor Torque Adjustment	16
Control Mode Description	17
Manual Angle Lock	18
DC 8.0 V Power Outlet Usage	19
■ APP Operations	
Instruction of Image Transmission System and ZY Play	20

Download APP	20
How to Connect Stabilizer to Smartphone/Tablet	21
ZY Play Main Functions	21

■ Calibration and Firmware Upgrade

When do you need to calibrate the stabilizer?	22
Initialization Method	22
Six-side Calibration	23
Motor Fine-tuning	25
Stabilizer Firmware Upgrade	25
Servo Follow Focus and Servo Zoom/Focus Controller Firmware Upgrade	25

■ Trouble Shooting

Trouble Shooting	26
------------------------	----

■ Product Specifications

■ Disclaimer and Warning

■ Warranty Terms

■ Contact Card

Packing List

The product package comes with the following items. In case that any item is found missing, please contact ZHIYUN or your local selling agent.

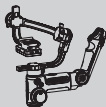

CRANE 3 LAB Stabilizer
× 1



Tripod × 1

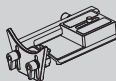

Quick Release Plate × 1



HDMI Mini to HDMI Micro
HD HDMI Cable × 1



HDMI Mini to HDMI Mini
HD HDMI Cable × 1

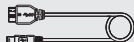

USB 3.0 to USB Mini
Camera Control Cable × 1



USB 3.0 to USB Micro
Camera Control Cable × 1



USB 3.0 to Multi
Camera Control Cable × 1



USB 3.0 to Type-C
Camera Control Cable × 1

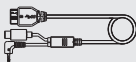

USB 3.0 to USB Mini 8P
+ $\phi 2.5\text{mm}$ plug
Camera Control Cable × 1

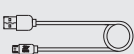

Micro USB Cable × 1

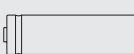

18650 Li-Ion Battery × 3



18650 Li-Ion Battery
Charger × 1



Quick Start Guide × 1







USB Cable Storage
Box × 1

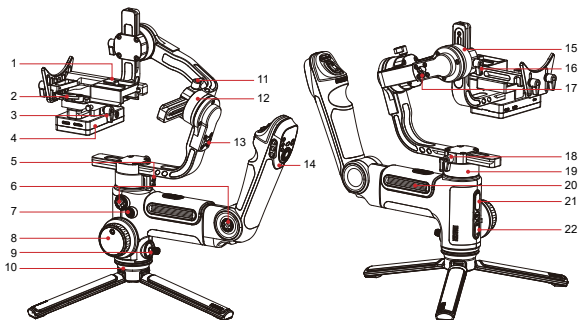

Storage Case × 1



Get to Know CRANE 3 LAB

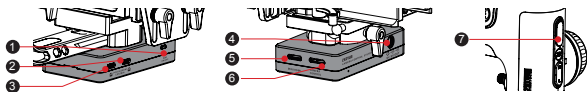

- | | |
|--|---|
| 1. Quick Release Plate | 12. Roll Axis Motor |
| 2. Quick Release Plate Latch | 13. Roll Axis Latch |
| 3. Quick Release Plate Thumb Screw | 14. Control Stick (see more on Page 12 ) |
| 4. Camera Image Transmission and Control Module (see more on Page 3 ) | 15. Tilt Axis Motor |
| 5. Pan Axis Latch | 16. Thumb Screw |
| 6. 1/4" Threaded Hole | 17. Tilt Axis Latch |
| 7. Power Button | 18. Thumb Screw |
| 8. Follow Focus Wheel | 19. Pan Axis Motor |
| 9. Joystick | 20. Battery Compartment |
| 10. Tripod | 21. USB Power Outlet |
| 11. Thumb Screw | 22. Mode Button (see more on Page 12 ) |

Camera Image Transmission and Control Module



No.	Interface	Function	Output	Input
1	WiFi Switch	Turn on/off the WiFi of the stabilizer	/	/
2	Servo Follow Focus & Servo Zoom/Focus Controller Interface	Connect and control servo follow focus or servo zoom/ focus controller	11V/2A	Forbidden
3	Servo Follow Focus & Servo Zoom/Focus Controller Interface	Connect and control servo follow focus or servo zoom/ focus controller	11V/2A	Forbidden
4	DC 8.0V Power Outlet	Can be used to charge cameras such as Canon 5D series (see more on Page 19 )	8V/2A	Forbidden
5	Mini HDMI Interface	Receive HDMI video signals from the camera	/	/
6	Camera Control Interface	1. Connect and control the camera via the control cable. For more information please refer to ZHIYUN Camera Control Cable Instruction (see more on Page 8 ) 2. Can be used to charge mirrorless cameras such as Sony mirrorless cameras	5V/1A	Forbidden
7	USB Charging Outlet	Can be used to charge external devices such as mobile phones	5V/1A	Forbidden

 The stabilizer does not support direct charge from the USB interface or any other interfaces above.

When using CRANE 3 LAB for the first time, please fully charge and activate the batteries with the dedicated charging device contained in the package to ensure normal use of the product.

Charger and Battery Description

Charger Specifications

Name: 18650 Li-Ion Battery Charger

Model: ZC-18650-3

Input: 5V – 2400mA

Output: 4.2V – 800mA*3

- Shines solid RED light when charging.
- Shines BLUE light when fully charged.

Battery Specifications

Name: 18650 Li-Ion Battery

Model: 18650

Capacity: 2600mAh

Voltage: 3.6V

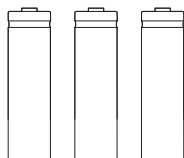
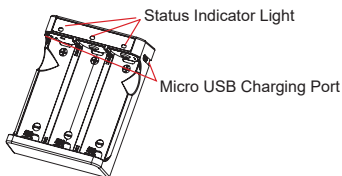

1. It is recommended to use original ZHIYUN 2600mAh Li-ion battery with the CRANE 3 LAB for longer runtime.
 2. The ZC-18650-3 battery charger is designed for 18650 Li-ion battery only. Please do not use it to charge batteries of other models or brands or else accidents may arise thereby.
- ⚠️**
1. The stabilizer is equipped with high-energy density batteries, which may cause fire, economic loss or personal injury when not properly used and stored. Please read the disclaimer and warning herein as well as the description on the battery label carefully before using the batteries.
 2. Please use batteries provided or approved by ZHIYUN only. ZHIYUN will not take any responsibility for explosion, fire and/or accidents caused by non-ZHIYUN batteries.

When the batteries are not in use, please be sure to put them in the battery slot of the package or in plastic storage cases.

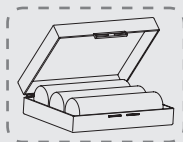
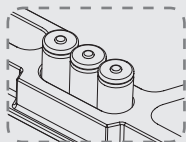

Charging Procedure

1. Insert the batteries into the charger in the right direction (positive/negative end) accordingly.
2. Connect the charger to the adapter via the Micro USB cable.
3. Plug the adapter into a power outlet to start charging.

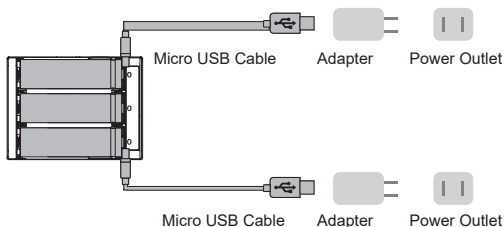

- 💡 1. Micro USB 5V charging ports are on both sides of the charger. Users are free to charge battery from one side of the charger or both of them. Charging from both of the charging ports will take less time.
 - 2. Charging the batteries may fail when the power supply is insufficient (for instance, when the current of the adapter is lower than 1000mA). Conditions may vary depending on the specific chargers used. It is recommended to use an adapter with higher current capacity;
 - 3. The battery cannot be charged through the USB port on the stabilizer.
- ⚠️ 1. Please use qualified standard 5V/≥2000mA adapter for battery charging; charging time depends on the maximum input current of the adapter.
 - 2. This stabilizer comes standard with dedicated high-discharge-rate batteries. Please use batteries provided or approved by ZHIYUN only.
 - 3. Please make sure the batteries are fully charged. Undercharged battery or batteries can lead to the failure of the stabilizer.

Tripod Installation

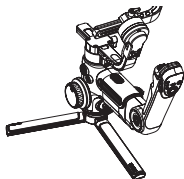
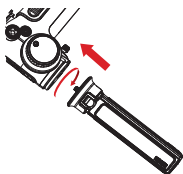

- Mount the tripod to the bottom of the stabilizer, then unfold the tripod on a flat surface.

- 💡 Place one tripod leg in parallel with the handle of the stabilizer to achieve maximum stability (as shown above).

Battery Installation

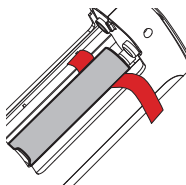
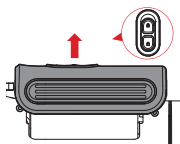

- Unlock the battery compartment and remove the battery cover, then insert 3 18650 batteries in the right direction (positive/negative end).

- Please put the lifting strap at the bottom of the battery compartment for easy lifting of the batteries.

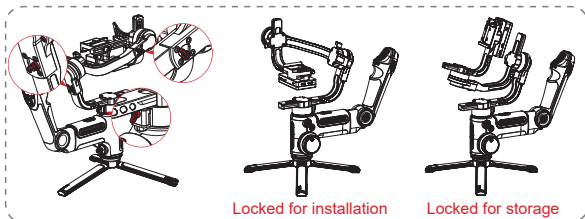

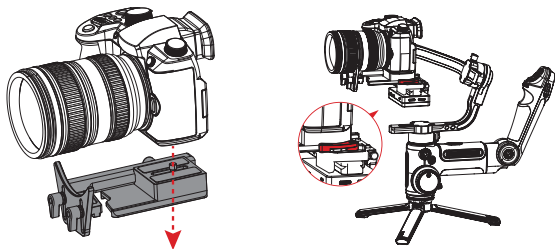

- Each axis of the stabilizer is equipped with a latch. You can use these latches to lock the axes for convenient installation and storage.

Camera Installation



- Take out the quick release plate, mount the camera on the quick release plate then tighten the 1/4" screw at its bottom.
- Adjust the lens support on the quick release plate to make sure the stability of the lens.
- Slide the quick release plate to the stabilizer with three axes locked, then lock the quick release plate latch.

 Before mounting the camera, make sure it is prepared ahead of time. Remove the lens cap and make sure the camera's battery and memory card are already inserted.

 Lift the quick release plate latch up if it gets stuck. Adjust the position of quick release plate latch to ensure the camera is neither too tight nor too loose.

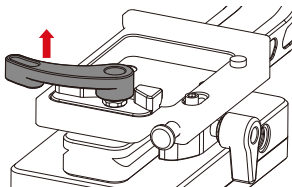

Data Cable Connection

Connect the camera and the stabilizer with the camera control cable and HD HDMI cable that come standard with the stabilizer.

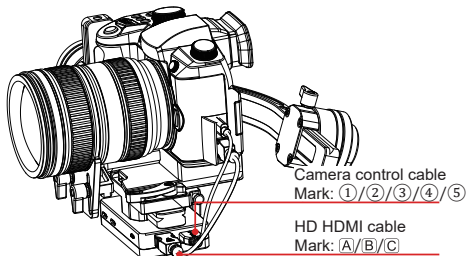

ZHIYUN Cable Collocation Illustration

Mark	①	②		③	④		⑤	
Connector Type	USB 3.0 to USB Mini	USB 3.0 to USB Micro		USB 3.0 to Multi	USB 3.0 to USB Mini 8P + Φ2.5mm plug		USB 3.0 to Type-C	
Mark	B			A			C	
Connector Type	HDMI Mini to HDMI Mini			HDMI Mini to HDMI Micro			HDMI Mini to HDMI	
Camera Model	Canon			Nikon	Sony		Panasonic	
	5D3	5D4	1DX2	D850	A7M3	A7RM3	GH4	GH5
Photo	√	√	√	√	√	√	√	√
Video	√	√	√	√	√	√	√	√
Live Preview	√	√	√	√	×	×	×	×
AV	√	√	√	√	√	√	×	√
TV	√	√	√	√	√	√	×	√
ISO	√	√	√	√	√	√	×	√
EV	√	√	√	√	√	√	×	√
Digital Zoom	×	×	×	×	√	√	×	×
AF	√	√	√	√	√	√	√	√
Manual Electronic Follow Focus	√	√	√	√	×	×	×	×
Image Transmission	√	√	√	√	√	√	√	√

1. Please check the website for complete compatible list.
2. Image transmission is available only for cameras whose HDMI output are 720P or 1080P.
3. If your camera uses HD HDMI cable C, please consult ZHIYUN service team for available sellers.
4. When applying the image transmission function of the stabilizer or using external monitor with Sony cameras, it is not recommended to use video mode as there will be no output from the HDMI port.
5. In video mode, parameter settings are unavailable for Sony, Panasonic cameras and some Canon cameras.
6. Please connect the control cable to camera and stabilizer in power off state and avoid hot-swapping as possible.

- 💡 To protect the stabilizer from being interfered with by the cables, you can tie up the cables with the magic strap that comes standard with CRANE 3 LAB as shown below.

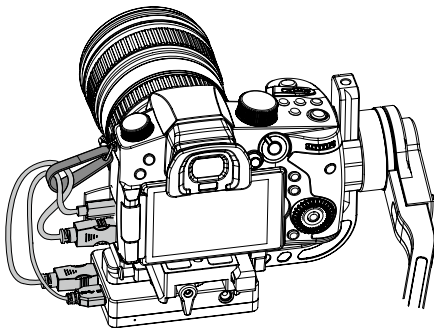

Balance Adjustment

 To facilitate the adjustment procedure, we recommend locking the three axes before the adjustment and unlock and adjust them one by one.

- Loosen the quick release plate thumb screw and make the camera grip as close to the tilt axis motor as possible.

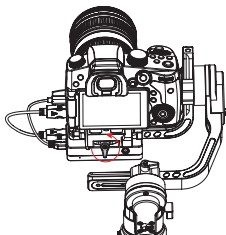

- Unlock the tilt axis and the quick release plate latch, push the camera to move forward or backward until the camera can stay still and almost level with its lens facing front (as shown on the right), then lock the quick release plate latch.

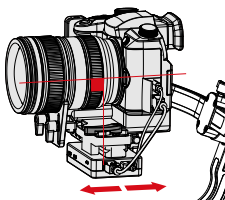

- Make the lens face up, slightly loosen the thumb screw of the tilt axis, push the camera to move forward or backward until the camera can stay still with the lens facing up (i.e. the camera stays still and vertical to the ground as shown on the right). Complete this step by tightening up thumb screw.

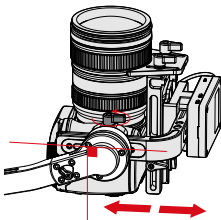

- Unlock the roll axis, slightly loosen the thumb screw of it, push the camera to move left or right until the camera can stay still and horizontal to the ground (as shown on the right). Complete this step by tightening up thumb screw.

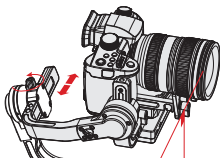

- Unlock the pan axis, slightly loosen the thumb screw of it, then adjust the pan axis until it stays still and horizontal to the ground (as shown on the right). Complete this step by tightening up thumb screw.

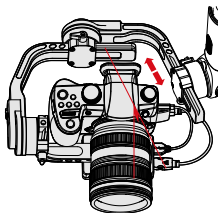

- 💡 1. Before turning on the stabilizer, please make sure the motors are unlocked and are free to move. Turning on the stabilizer with the motors locked will result in overheating of the motors and cause damages.
- 2. The balance of the stabilizer will help it to achieve the best performance and prolong its runtime.

- 💡 Pull the quick release plate thumb screw out a little if it becomes stuck during the installation.

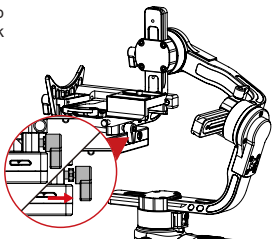

Buttons Description

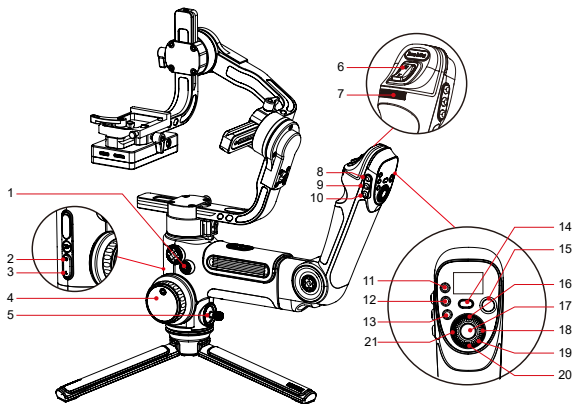
**1. Power Button** [⏻]

- Long press for 3 seconds to power on/off the stabilizer.
- Double press to enter or exit standby mode.

2. Pan Following Mode

Single click to enter Pan Following Mode.

3. Locking Mode

Single click to enter Locking Mode.

4. Follow Focus Controller*

- Once Servo Follow Focus (Lite) is connected to the stabilizer, the follow focus controller will be able to control it.
- Electronic follow focus control is available on some Canon and Nikon cameras via the follow focus controller. [For more information please refer to CRANE 3 LAB Compatible List.](#)

5. Joystick

Four-way direction control of the camera/lens on the stabilizer.

6. Zoom Rocker*

- Once Servo Zoom/Focus Controller (Max) (sold separately) is connected to the stabilizer, the Zoom Rocker will be able to control it.
- Connecting the stabilizer to Sony cameras with motorized lens, the zoom controller will be able to operate optical zooming; connecting the stabilizer to Sony

*TransMount Servo Follow Focus Motor Installation. Please refer to the user manual.

cameras with non-motorized lens, the zoom controller will be able to operate digital zooming. [For more information please refer to CRANE 3 LAB Compatible List.](#)

7. Parameter Dial

Rotate the dial to quickly set camera parameters.

8. Following Mode [F]

Single click to enter Following Mode. Click again to return to previous mode.

9. POV Mode/Vortex Mode [POV]

- Single click to enter or exit Point of View Mode. Click again to return to previous mode.
- Double click to enter or exit Vortex Mode. Click again to return to previous mode.

10. Reset [RE]

Single click to reset the motor to the starting point of the current mode.

11. TV [TV]

Single click to set shutter speed.

12. AV [AV]

Single click to set aperture value.

13. ISO [ISO]

Single click to set ISO value.

14. PhoneGo Mode [GO]

Press and hold to enter and stay in PhoneGo Mode which enables fast following speed of the three axes on the stabilizer.

15. Video [●]

Single click to start/end video recording.

16. Live Preview [LV]

Single click to control the camera to flip up the reflex mirror to enter Live Preview mode.

17. Photo

- Half press to enable automatic zoom function of the camera.
- Full press to take photo.

18. Right [►]

- In main screen, single press to move to next option.
- In menu screen, single press to confirm selection.

19. Dial

In menu screen, rotate the dial to switch between options.

20. Menu [●●●]

Single press to enter or exit menu screen.

21. Left [◀]

- In main screen, single press to move to previous option.
- In menu screen, single press to return to previous screen.

1. When powering on the stabilizer, please hold the camera with one hand in case of malfunctioned rotation.
2. When powering on, avoid shaking of the stabilizer hand grip which may lead to start-up failure.
3. Single click ISO button and click Right button to choose ISO value.

OLED Display Description



Interface where camera
params settings are
available



Interface where camera
params settings are
unavailable



Menu Interface

Icon Description:

	Camera successfully connected to stabilizer
	Video Mode
	Photo Mode
	Battery Level (stabilizer)
PF	Pan Following Mode
L	Locking Mode
POV	Point Of View Mode
F	Following Mode
GO	PhoneGo Mode
V	Vortex Mode
AV	Aperture Value
TV	Shutter Speed Value
ISO	ISO Value
	Exposure Value

Menu Option Description

motor (Motor Torque Setting)	low	Low-torque		
	medium	Medium-torque		
	high	High-torque		
wheel (Follow Focus Wheel Setting)	sensi (Follow Focus Wheel Sensitivity)	low	Low Sensitivity	
		medium	Medium sensitivity	
		high	High Sensitivity	
	ABpoint ¹	A	Set the current wheel position as A point	
		B	Set the current wheel position as B point	
		clear	Clear AB Points	
	priority (Priority on Wheel)	handle	Prioritize handle control	
		external	Prioritize external control ²	
		off	Disable follow focus wheel	
reverse	Control the wheel in reverse direction			
joystick (Joystick Setting)	reverse	vertical	Joystick in vertical direction	
		horizontal	Joystick in horizontal direction	
zoom rocker(Zoom Rocker Setting)	sensi (Zoom Rocker Sensitivity)	low	Low Sensitivity	
		medium	Medium Sensitivity	
		high	High Sensitivity	
	ABpoint ¹	A	Set the current position of the zoom rocker as A point	
		B	Set the current position of the zoom rocker as B point	
clear		Clear AB Points		
reverse	Control the zoom rocker in reverse direction			
calibration (Calibration Setting)	yes	Enter six-side calibration		
	no	Exit calibration setting		
angle (Fine-tuning on motor angle)	pitch	Fine tune the tilt axis motor		
	roll	Fine tune the roll axis motor		
focus (Follow Focus and Zoom/Focus Controller Setting)	Lite	upgrade	Upgrade firmware of Servo Follow Focus (Lite) ³	
	Max	upgrade	Upgrade firmware of Servo Zoom/Focus Controller (Max) ³	
about	Information of image transmission firmware version, names of WiFi and Bluetooth. Press Right button for stabilizer firmware version.			

 "1" AB point settings are only available when connecting to ZHIYUN Servo Follow Focus correctly.

"2" External control refers to remote control via Bluetooth or cable controls other than local controls via the stabilizer. (remote controls need to be purchased separately).

"3" Servo Follow Focus (Lite) and Servo Zoom/Focus Controller (Max) need to be purchased separately.

Motor Torque Adjustment

The motor torque of the stabilizer needs to be adjusted (3 levels) to adapt the stabilizer to cameras and lens of different weight for ideal use.

How to adjust:

● motor
wheel
joystick

1. Single press the Menu button and rotate the dial to "motor", then press Right button to enter motor torque setting.

|● low
medium
high

2. Rotate the dial to choose the appropriate motor torque level and press Right button to confirm.

Option	Weight Capacity	Compatible Camera & Lens Examples
low (default)	Low	Sony A7 series+Sonnar T* FE 35mm F2.8 ZA
medium	Medium	Canon 5D series+EF 50mm f/1.4 USM
high	High	Canon 5D series+EF 24-70mm f/2.8L II USM

⚠ Motor torque levels that are too high or too low may result in shakiness of the stabilizer and affect its performance.

Control Mode Description

-  Motors circled in red are free to move in line with the movement of the stabilizer handle while motors circled in grey are locked.

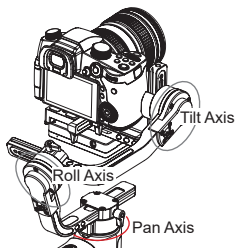

Pan Following Mode (PF): Single click PF mode button to enter

The camera pans left/right following the movement of the stabilizer while the tilt and roll axes are locked. Push the joystick up/down to control the tilt axis.

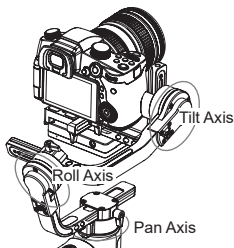

Locking Mode (L): Single click Locking mode button to enter

This mode locks the movement of all three axes to keep the camera fixed on a shooting direction. Pushing the joystick up/down and left/right allows manual control of the tilt axis and pan axis.

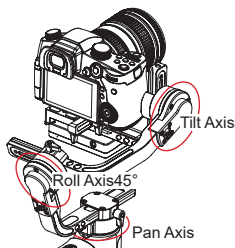

Point of View Mode (POV): Single click POV mode button to enter

This mode allows the camera to roll left/right at a Max. angle of 45° and all the three motors with unlimited 360° rotation following the movement of the stabilizer.

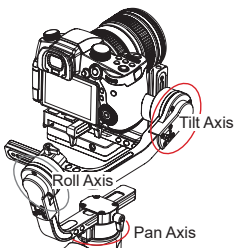

Following Mode (F) : Single click Following mode button to enter

The camera pans and tilts following the movement of the stabilizer. Pushing the joystick left/right allows manual control of the roll axis.

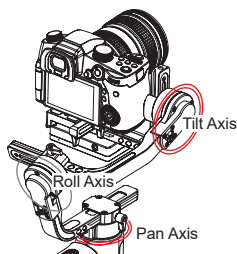

PhoneGo Mode (GO): Press and hold PhoneGo mode button to enter. The camera pans left/right and tilts up/down following the movement of the stabilizer in fast speed while the roll axis is locked.

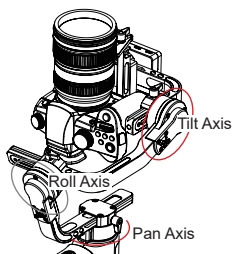

Vortex Mode (V): Double click POV mode button to enter. The camera tilts with a 90° angle following the movement of the handle while the roll axis is locked. Please use this mode in an underslung gesture and push the joystick right/left to rotate the pan axis.

Manual Angle Lock

Under pan following mode (PF) and locking mode (L), you can manually rotate the camera to a certain angle, then loosen the grip and the camera position will be fixed. Under pan following mode (PF), you can manually adjust the angle of tilt axis. Under locking mode (L), you can manually adjust the angle of pan axis and tilt axis.

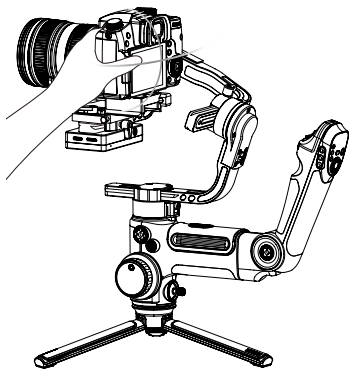

DC 8.0 V Power Outlet Usage

The DC 8.0 V power outlet on the side of the stabilizer can be used for charging the Canon 5D camera through a DC connector DR-E6 (purchase separately).

Charging 5D3/5D4 camera:

Powering on:

1. First, connect the power input end of the connector to the DC 8.0V power outlet, then connect the other end of the connector to the camera.
2. Install the camera to the stabilizer and power on the stabilizer, then start up the camera.

Powering off:

First, power off the camera, then unplug the connector from the stabilizer.

Charging 5D2 camera:

Powering on:

1. Start up the stabilizer, double click the power button to enter standby mode.
2. Connect the power input end of the connector to the DC 8.0V power outlet, then connect the other end of the connector to the camera.
3. Install the camera to the stabilizer and balance the stabilizer.
4. Power on the camera and double click the power button to activate the stabilizer.

Powering off:

First, power off the camera, then unplug the connector from the stabilizer.

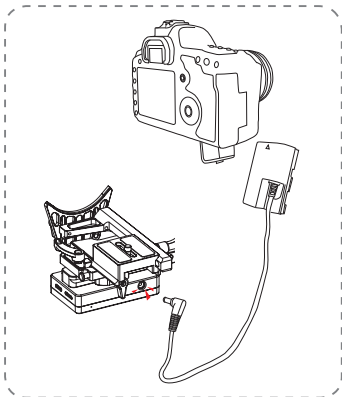

- ⚠** 1. Original Canon DR-E6 DC power connector is recommended; Please follow the procedure herein in case of accidents.
2. Please power on/off the camera in accordance with the procedure, otherwise the camera may fail to start.

Instruction of Image Transmission System and ZY Play

1. CRANE 3 LAB image transmission system can only be applied when combined with ZY Play.
2. Before applying image transmission function, please confirm that the camera control cable and HDMI cable are properly connected.
3. For Sony cameras, please select PC Remote in USB Connection. In PC Remote Settings, please select PC+Camera for Still Image Save Destination. For LUMIX cameras, please select PC (Tether) in USB mode.
4. With the TransMount Phone Holder with Crown Gear (need to be purchased separately), it is easier to mount the phone on the stabilizer and adjust the viewing angle of the phone screen.

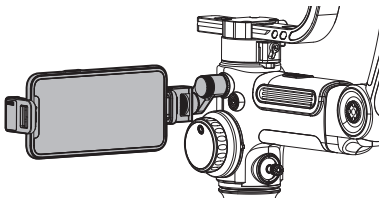

Download APP



Scan the QR code on the left (Android 5.0 and above, iOS 9.0 and above required) or search "ZY Play" in App Store or Google Play to download.

1. Pair with ZY Play designed for CRANE 3 LAB, which enables you to make better use of its various functions.
2. ZY Play is subject to change without prior notice. Please always refer to the latest version.

How to Connect Stabilizer to Smartphone/Tablet

1. Connect stabilizer with camera with the corresponding camera control cable and HDMI cable. After balance adjustment, power on the stabilizer. Turn on Bluetooth and WiFi on the mobile device.
2. Open ZY Play and select the product page of CRANE 3 LAB. Click "connect device", and select the stabilizer with the corresponding Bluetooth name (check the name of your Bluetooth in About, naming format: CRANE 3 LAB_XXXX).
3. Tap the WiFi icon [📶] and connect to the stabilizer's WiFi according to the prompts (Initial password: 12345678).

ZY Play Main Functions



When do you need to calibrate the stabilizer?

Please calibrate the stabilizer when necessary.

When	How
<ol style="list-style-type: none"> 1. Slight deviation is found in the tilt angle of the camera in level position after turning on. 2. Slight deviation is found in the roll angle of the camera in level position after turning on. 3. Frequent small angle correction is found when the camera is in level position while the stabilizer stays still. 	Initializing the stabilizer
<ol style="list-style-type: none"> 1. Slight deviation is found in the level position after the initialization of the stabilizer. 2. The stabilizer has not been used for a long time. 3. The stabilizer undergoes significant temperature difference in operation environments. 	Six-side calibration
Slight deviation is found in the tilt or roll angle of the camera in level position after initialization and six-side calibration of the stabilizer.	Fine tuning the motors

Initialization Method

1. Correctly install the batteries.
2. Hold the quick release plate with one hand. Long press the power button to turn on stabilizer. After powering on the stabilizer, motors will produce forces. Please hold tight the quick release plate and double click the power button to enable the stabilizer to enter standby mode.
3. Put the stabilizer still on a table surface, and wait for about 30 sec., and the stabilizer will automatically complete initialization.

Six-side Calibration

A. Six-side calibration via OLED display guide:

1. Power on the stabilizer and enter standby mode, then press Menu and rotate the dial to "Calibration" option. Press right to confirm.
2. As seen below, conduct six-side calibration following the 6 steps shown in the graphs, finish by pressing any button to exit the menu.

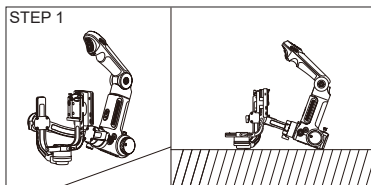

Press the motor of the tilt axis against a level surface and wait until the display of the stabilizer shows "STEP 2" (as shown above).

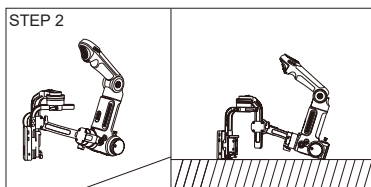

Press one side of the camera image transmission and control module against a level surface and wait until the display of the stabilizer shows "STEP 3" (as shown above).

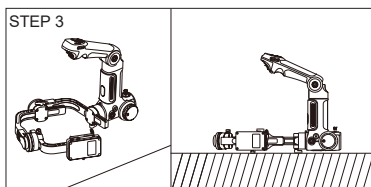

Press another side of the camera image transmission and control module against a level surface and wait until the display of the stabilizer shows "STEP 4" (as shown above).

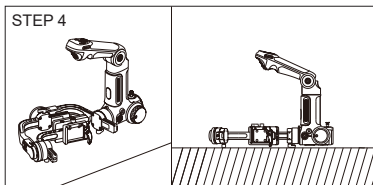

Press the latch on the tilt axis arm against a level surface and wait until the display of the stabilizer shows "STEP 5" (as shown above).

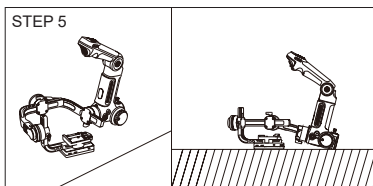

Press another side of the camera image transmission and control module against a level surface and wait until the display of the stabilizer shows "STEP 6" (as shown above).

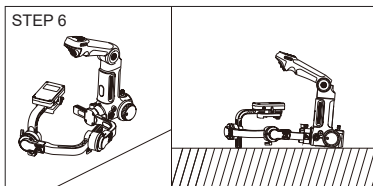

Press another side of the tilt axis arm against a level surface and wait until the display of the stabilizer shows "√" (as shown above).

B. Six-side calibration through APP

Connect the stabilizer to ZY Play, enter "Calibration" and finish six-side calibration following the APP instruction.

 In simple terms, six-side calibration is to place all six sides of the camera image transmission and control module in vertical to a level surface respectively.

Motor Fine-tuning

Fine tune the motor through stabilizer:

1. Power on the stabilizer and enter standby mode, then rotate the dial and press right to enter the "angle" option;
2. Adjust the value of the tilt and roll axis angle to your actual needs.

Fine tune the motor through APP:

Connect the stabilizer to ZY Play. Enter "Gimbal Settings", and adjust the value of the tilt and roll axis angle to your actual needs.

Stabilizer Firmware Upgrade

ZY Play will automatically search for the latest firmware after the stabilizer is connected. Tap to upgrade automatically.

1. Before upgrading the firmware, please make sure that the power levels of both stabilizer and phone are above 30%. Do not turn off the stabilizer during upgrade.
2. Please do not use the stabilizer during the upgrade.

Servo Follow Focus and Servo Zoom/Focus Controller Firmware Upgrade



1. If the stabilizer firmware includes that of the servo follow focus and servo zoom/focus controller users can upgrade the firmware of servo follow focus and servo zoom/focus controller after upgraded the firmware of the stabilizer.
2. Properly connect Servo Follow Focus (Lite) and Servo Zoom/Focus Controller (Max) to the stabilizer, press Menu button to select focus-->Lite/Max-->upgrade. During the upgrading, the status indicators of the two motors will flash quickly. Restart the stabilizer after the upgrade.(Note that the two Zoom/Focus Controllers should be upgraded one by one)

⚠ Please select the correct name of the servo follow focus or servo zoom/focus controller to upgrade, otherwise it may affect their performance or result in malfunction.

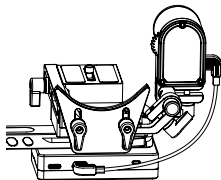
1. Servo Follow Focus (Lite) and Servo Zoom/Focus Controller (Max) are not included in the standard package. Please purchase them separately according to your needs.



Trouble Shooting

Performance	Cause	Treatment
 <p>over heat</p> <p>The word "over heat" icon appears on the stabilizer screen</p>	The ambient temperature is too high	Make sure the stabilizer is used under temperature between -10 and 45 degrees
	Overweight	Make sure the weight on stabilizer is between 650 and 4500g.
	The stabilizer is not balanced	Please balance the stabilizer according to the steps in the manual. Restart the stabilizer after stabilizer temperature returns to normal.
	The safety lock on axis is not released	Release the stabilizer safety lock switch.
	The cable interferes with the stabilizer	Make sure the connection cable doesn't interfere with the motor. Restart the stabilizer after stabilizer temperature returns to normal.
 <p>axis lock</p> <p>The stabilizer makes five times of "Di" sound in a row, and the screen shows "axis lock".</p>	The stabilizer safety lock is not released	Release the stabilizer safety lock switch.
The quick release plate of the stabilizer cannot be locked	Quick release plate locking latch has reached the lock limit	If the quick release plate is too tight or too loose, you can lift up the quick release plate locking latch and adjust the starting position of the latch to achieve the most appropriate state of tightness. Please refer to page 7 of the manual for details.
The pan axis cannot be rotated under Vortex Mode.	The stabilizer is not well balanced	Please follow the steps in the manual to make balance adjustment. Specifically pay attention to balance adjustment on pan axis
The "X" icon appears on the stabilizer screen	Internal problem of stabilizer	Please contact the after-sales service for return.
After the stabilizer starts up, the motor is "weak".	Internal problem of stabilizer	Please contact the after-sales service for return.

*If the above troubles cannot be eliminated or others occur, please contact ZHIYUN official after-sales service.

Product Model: CR103

	Min.	Standard	Max.	Remark
Operation Voltage	9.8V	11.1V	12.6V	
Operation Current	360mA		5400mA	
Charging Voltage	-	-	-	
Charging Current	-	-	-	
Mobile Phone USB Output Voltage	-	5V	-	
Mobile Phone USB Output Current	-	-	1A	
Camera USB Output Voltage	-	5V	-	
Camera USB Output Current	-	-	1A	
Camera Charging Port Output Voltage	-	8V	-	
Camera Charging Port Output Current	-	-	2A	
Tilt Mechanical Range	-93°	273°	+180°	
Roll Mechanical Range	-	360°	-	Unlimited Rot.
Pan Mechanical Range	-	360°	-	Unlimited Rot.
Working Temperature	-10°C	25°C	45°C	
Battery Runtime		-	7.5h	Lab Data ¹
Charging Time	-	4h	-	Charging Current 2400mA
Valid Payload	650g	-	4500g	
Bluetooth			Bluetooth 5.0	
WIFI	Maximum effective range of image transmission signal in WIFI 2.4G: 50m (no occlusion, no interference)			

The runtime datum, 7.5 hours, is collected through a complete test session in which the stabilizer is well balanced with Sony A7 and 16-35mm F2.8 lens installed. The ambient temperature is 25-degree Celsius and the combo is placed at rest throughout the test session.

Note: Data in this user guide are collected through lab tests carried out by ZHIYUN.

Thank you for purchasing ZHIYUN CRANE 3 LAB. The information contains herein affects your safety, legitimate rights and obligation. Please read this instruction carefully to ensure proper configuration before use. Failure to read and follow this instruction and warnings herein may result in serious injury to you or bystanders, or damage to your device or property. Guilin Zhishen Information Technology Co., Ltd. reserves all rights for final explanation on this instruction and other documents related to CRANE 3 LAB. The information is subject to update without notice. Please visit www.zhiyun-tech.com to obtain the latest product information.

By using this product, you hereby signify that you have read this document carefully and that you understand and agree to abide by the terms and conditions herein. You agree that you are solely responsible for your own conduct while using this product, and for any consequences thereof. You agree to use this product only for purposes that are proper and in accordance with all terms, precautions, practices, policies and guidelines ZHIYUN has made and may make available.

ZHIYUN accepts no liability for damage, injury or any legal responsibility incurred directly or indirectly from the use of this product. Users shall observe safe and lawful practices including, but not limited to, those set forth herein.

ZHIYUN™ is the trademark of Guilin Zhishen Information Technology Co., Ltd. (hereinafter referred to as "ZHIYUN" or "ZHIYUN TECH") and its affiliates. All product names or marks referred to herein are trademarks or registered trademarks of their respective holders.

Reading Tips

Legends:  Hints and Tips

 Important

Warnings

Read the ENTIRE User Guide to become familiar with the features of this product before operating. Failure to operate the product correctly can result in damage to the product or personal property and cause serious injury. This is a sophisticated product. It must be operated with caution and common sense and requires some basic mechanical ability. Failure to operate this product in a safe and responsible manner could result in injury or damage to the product or other property. This product is not intended for use by children without direct adult supervision. DO NOT use with incompatible components or in any way otherwise as mentioned or instructed in the product documents provided by ZHIYUN. The safety guidelines herein contain instructions for safety, operation and maintenance. It is essential to read and follow all of the instructions and warnings in the User Guide, prior to assembly, setup or use, in order to operate the product correctly and avoid damage or serious injury.

Safe Operation Guidelines

■ CAUTION:

1. CRANE 3 LAB is a high-precision device. Damage may be caused to CRANE 3 LAB if it is dropped or subject to external force, and this may result in malfunction.
2. Make sure the rotation of the stabilizer axes is not blocked by external force when CRANE 3 LAB is turned on.
3. CRANE 3 LAB is not waterproof. Prevent contacts of any kind of liquid or cleaner with CRANE 3 LAB. It is recommended to use dry cloth for cleaning.
4. Protect CRANE 3 LAB from dust and sand during use.

■ WARNING

To avoid fire, serious injury, and property damage, observe the following safety guidelines when using, charging, or storing your batteries.

Battery Use

1. Prevent the batteries to come into contact with any kind of liquid. Do not leave batteries out in the rain or near a source of moisture. Do not drop the battery into water. If the inside of the battery comes into contact with water, chemical decomposition may occur, potentially resulting in the battery catching on fire, and may even lead to an explosion.
2. If the battery falls into water with the stabilizer during use, take it out immediately and put it in a safe and open area. Maintain a safe distance from the battery until it is completely dry. Never use the battery again, and dispose of the battery properly as described in the Battery Disposal section below.
3. If the battery catches fire, use water, water spray, sand, fire blanket, dry powder, or carbon dioxide fire extinguisher immediately to put out the fire. Battery-caused fire may lead to explosion. Please extinct the fire by applying the methods recommended above according to the actual situation.
4. Never use non-ZHIYUN batteries. If replacement or backup is needed, please purchase new batteries from ZHIYUN's official website or authorized channels. ZHIYUN takes no responsibility for any damage caused by non-ZHIYUN batteries.
5. Never use or charge swollen, leaky, or damaged batteries. Never use or charge if the battery smells, or overheats (exceeding maximum temperature of 160°F/71°C). If your batteries are abnormal, contact ZHIYUN or a ZHIYUN authorized dealer for further assistance.
6. The battery should be used within the temperature range from -10°C to 45°C. Use of battery in environments above 45°C may lead to a fire or explosion. Use of battery below -10°C may lead to serious battery damage.
7. Do not use the battery in strong electrostatic or electromagnetic environments. Otherwise, the battery protection board may malfunction.
8. Do not disassemble or use any sharp object to puncture the battery in any way. Otherwise, the battery may leak, catch fire or explode.
9. Do not mechanically strike, crush, or throw the battery. Do not place heavy objects on the battery or charger.
10. Electrolytes inside the battery are highly corrosive. In case of accidental contact of any electrolytes with your skin or eyes, rinse immediately with water for at least 15 minutes and seek medical advice as soon as possible.
11. Do not use the battery if it has been involved in a crash or heavy impact.
12. Do not heat the battery and never put the battery in a microwave oven or in a

pressurized container.

13. Do not place the battery on a conductive surface (such as a metal desk surface, eye-glasses, watch, jewelry, etc.)
14. Prevent use of wires or other metal objects that could cause positive and negative short-circuit to the battery.
15. If the battery terminal is dirty, wipe it with a clean, dry cloth. Otherwise it will cause a bad battery connection, which may result in energy loss or charging failure.

Battery Charging

1. The battery will automatically stop charging once it is full. Please disconnect the battery and the charger when fully charged.
2. Do not attach the batteries to a wall outlet or car charger socket directly. Always use a ZHIYUN approved adapter for charging. ZHIYUN takes no responsibility if the battery is charged using a non-ZHIYUN charger.
3. Do not put the battery and charger near flammable materials or on flammable surfaces (such as carpet or wood). Never leave the battery unattended during charging to prevent any accident.
4. Do not charge the battery immediately after use, because the battery temperature may be too high. Do not charge the battery until it cools down to normal room temperature. Charging the battery with its temperature over 45°C or lower than 0°C may lead to leakage, overheating, or damage.
5. Examine the charger before use, make sure there is no damage to the enclosure, cord, plug, or other parts. Never use a damaged charger. Do not clean the charger with any liquid containing alcohol or other flammable solvents. Disconnect the charger when not in use.

Battery Storage

1. Keep batteries out of the reach of children and pets.
2. Do not leave the battery near heat sources such as a furnace or heater, or inside of a vehicle on hot days. Never expose the battery in any environment with temperature of over 60°C. The ideal storage temperature is 22°C-28°C.
3. Store batteries in a dry environment.
4. Do not leave the battery unused for too long after it has been completely discharged to prevent over-discharge of battery which may result in battery damage and permanent failure.

Battery Maintenance

1. Do not over-charge or over-discharge the battery, which will damage the battery.
2. The battery performance will be affected for not being used for a long time;
3. Never use the battery when the temperature is too high or too low.
4. Do not store the battery in any environment with a temperature of over 60°C.

Battery Disposal

1. Please fully discharge the battery before putting it in the designated recycling bin. Batteries contain hazardous constituents and it is forbidden to put the battery in general waste bin. For related details please abide by the local laws and regulations on battery recycling and disposal.
2. If the battery cannot be fully discharged, never put it in battery recycling bin. Please contact battery recycling companies for a proper solution.

Warranty Period

1. Customers are entitled to replacement or free repair service in case of quality defect(s) found in the product within 15 days upon receipt of the product.
2. Customers are entitled to free repair service from ZHIYUN for any product proven defective in material or workmanship that results in product failure during normal consumer usage and conditions within the valid warranty period, which is 12 months counting from the date of selling.
3. Some states or countries do not allow limitations on how long an implied warranty lasts, so the above warranty term may not apply to you.

Exceptions

1. Products subjected to unauthorized repair, misuse, collision, neglect, mishandling, soaking, accident, and unauthorized alteration.
2. Products subjected to improper use or whose labels or security tags have been torn off or altered.
3. Products whose warranty has expired.
4. Products damaged due to force majeure, such as fire, flood, lightening, etc.

Warranty Claim Procedure

1. If failure or any problem occurs to your product after purchase, please contact a local agent for assistant, or you can always contact ZHIYUN's customer service through email at service@zhiyun-tech.com or website at www.zhiyun-tech.com.
2. Your local agent or ZHIYUN's customer service will guide you through the whole service procedure regarding any product issue or problem you have encountered. ZHIYUN reserves the right to reexamine damaged or returned products.

Customer information

Customer Name :

Contact No :

Address :

Sales Information

Sales Date :

Prod. Serial No :

Dealer :

Contact No :

#1 Maintenance Record

Service Date :

Signature of Repairman :

Cause of Problem :

Service Result : Solved Unsolved Refunded
(Replaced)



Website



Weibo



Vimeo



Google+



Facebook
(Zhiyun Support)



Facebook
(Zhiyun Tech)



Youku



Youtube



Wechat



Instagram

Tel: +86 400 900 6868

USA Hotline: +1 808-319-6137,9:00-18:00 GMT-7,Mon-Fri

Europe Hotline: +49 (0) 61018132180,10:00-17:00 GMT+1,Mon-Fri

Web: www.zhiyun-tech.com

E-mail: service@zhiyun-tech.com

Address: 09 Huangtong Road, Tieshan Industrial Zone, Qixing District, Guilin, 541004, Guangxi, China

Certificate of Quality

This product is confirmed to meet quality standards and permitted for sale after strict inspection.

QC Inspector: _____



Please download the latest version from www.zhiyun-tech.com

This document is subject to change without notice.

ZHIYUN™ is a trademark of ZHISHEN.

Copyright © 2020 ZHISHEN. All rights reserved.

ZHIYUN-TECH.COM